

50744 Series (10 to 20 lbs)

Drawing

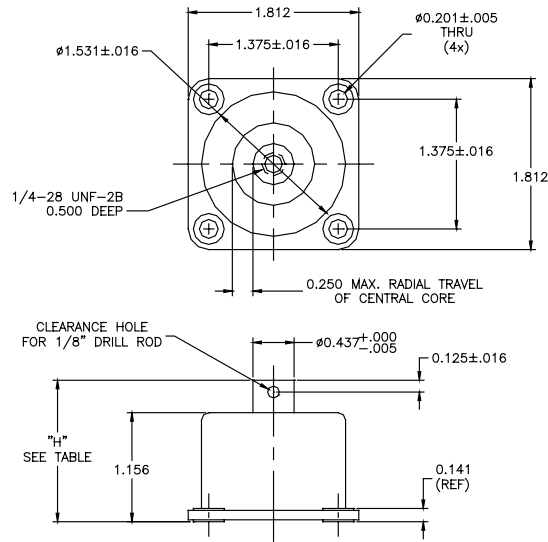

Load Ratings

Part Number	Max. Load (lbs.)
50744-1	10
50744-2	15
50744-3	20

	Height (H)
Compressed	1.19
Approx. Free	1.50
Max. Extended	1.88

Stiffness Curves

