

51507 Series (150 to 330 lbs)

Drawing

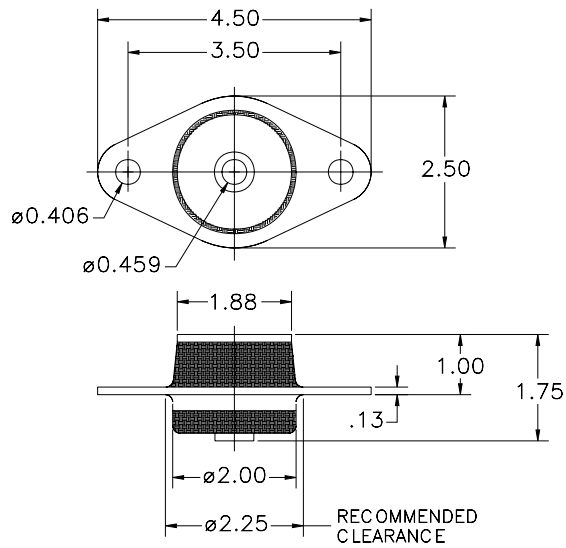

Load Ratings

Part Number	Color Code	Max. Axial Load (lbs.)	Max. Radial (lbs.)
51507-1	Red	150	100
51507-2	Green	200	150
51507-3	Blue	270	180
51507-4	White	330	220

Stiffness Curves

