

# 51508 Series (270 to 570 lbs)

## Drawing

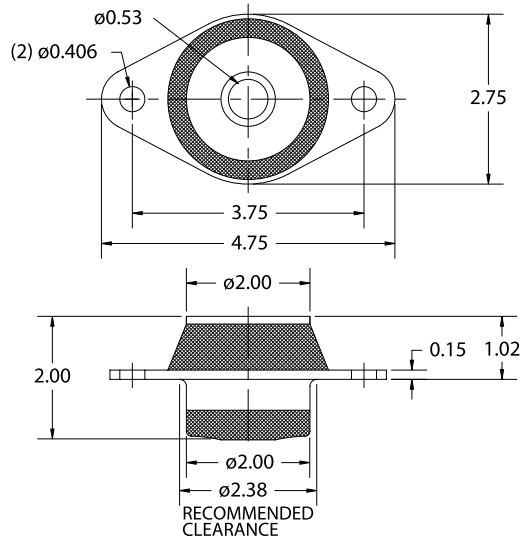

## Load Ratings

Part Number	Color Code	Max. Axial Load (lbs.)	Max. Radial (lbs.)
51508-1	Yellow	270	180
51508-2	Red	330	220
51508-3	Green	390	260
51508-4	Blue	480	320
51508-5	White	570	380

## Stiffness Curves

