

Size 3 Cupmounts (250 to 900 lbs)

Drawing

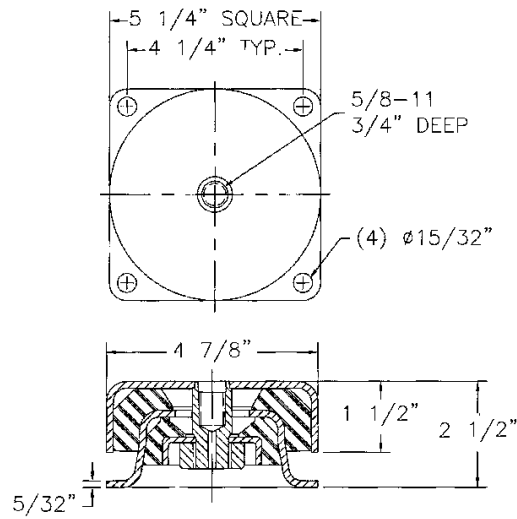

Load Ratings

Standard Neoprene Part Number	Max. Stationary Load (lbs.)	Vehicular Load Range (lbs.) – High Shock apps.
52101	250	65-100
52102	400	100-150
52103	650	150-200
52104	900	200-285

Stiffness Curves

