

52010 Series (110 to 265 lbs)

Drawing

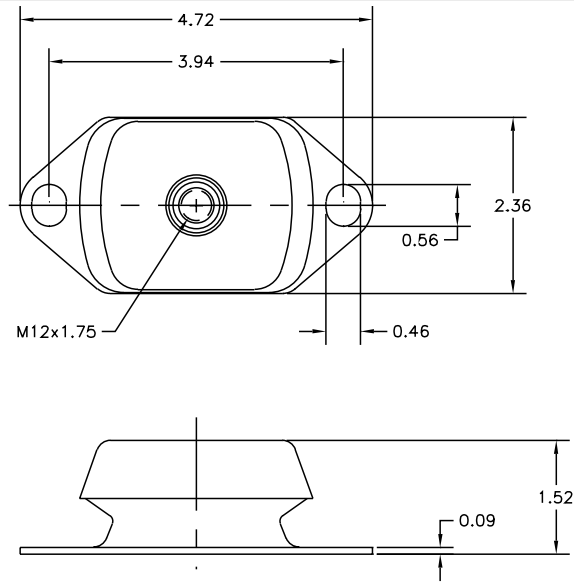

Load Ratings

Part Number	Max. Load (lbs)
52010-45	110
52010-55	145
52010-65	220
52010-75	265

Stiffness Curves

