

Pivotal Levelers



Patented Pivotal Levelers keep equipment level and isolate noise and vibration for about one-third to one-half the cost of ordinary machine mounts.





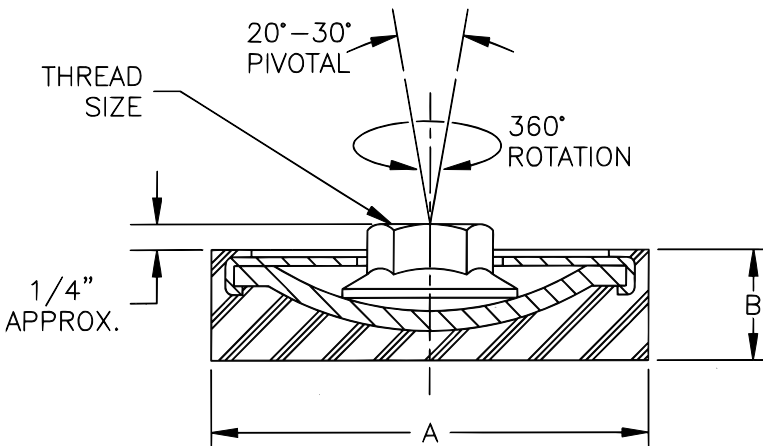

You can quickly and easily attach Pivotal Levelers to everything from computers and compressors to presses and pumps. These self-aligning, self-contained units handle

equipment up to 8,000 lbs., providing stability, isolation and shock protection while allowing complete portability. They permit 1/4" or more of leveling, depending on the attachment hardware used.

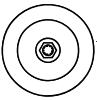
Pivotal Levelers are made of bonded neoprene/steel for long service life and resistance to ozone and oils.



Pivotal Levelers

Part No.	Color Code	Max. Load (lbs)	Configuration	Description	A	B	Thread
50510	Green	350		Square, with round hole and hex nut; free to rotate. *Available in stainless steel.	3"	5/8"	1/2-13
50520	White	700					
50530	Green	500		Round hole with hex nut; free to rotate. *Available in stainless steel.	3	3/4	1/2-13
50540	White	1000					
50531	Green	500		Pad type; no hex nut (1" diameter alignment hole)	3	3/4	N/A
50541	White	1000					
50532	Green	500		Hex Hole with hex nut, no rotation	3	3/4	1/2-13
50542	White	1000					
50534	Green	3700		Pad type; no hex nut (1" diameter alignment hole)	5	1 1/2	N/A
50544	White	8000					
50535	Green	3700		Round hole with hex nut; free to rotate.	5	1 1/2	3/4-10
50545	White	8000					
50536	Green	3700		Hex Hole with hex nut, no rotation	5	1 1/2	3/4-10
50546	White	8000					

Add -A to part number for 5" long epoxied stud and hex nut